

### Features

- 240Watts peak pulse power ( $T_P = 8/20\mu s$ )
- SOD-523FL package
- Bidirectional configurations
- Low clamping voltage
- Low leakage current
- Medium capacitance ( $C_j=20pF$  typ.)
- Protection one data/power line to:
  - IEC 61000-4-2  $\pm 15kV$  contact  $\pm 20kV$  air
  - IEC 61000-4-4 (EFT) 40A (5/50ns)
  - IEC 61000-4-5 (Lightning) 6A (8/20 $\mu s$ )

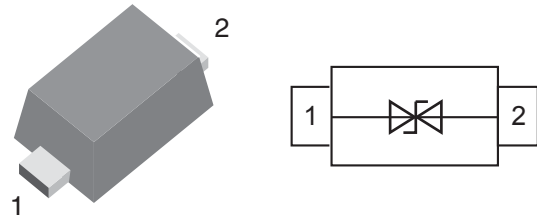

### Mechanical Data

- **Case:** SOD-523FL (plastic package).  
Lead free; RoHS compliant; Halogen free
- **Molding Compound Flammability Rating:**  
UL 94 V-0
- **Terminals:** High temperature soldering guaranteed:  
260 °C/10 sec. at terminals

### Applications

- Computers and peripherals
- Communication systems
- Notebook
- Cellular handsets and accessories
- Portable electronics
- Audio and video equipment

### Absolute Maximum Ratings

Ratings at 25 °C, ambient temperature unless otherwise specified

Parameter	Symbol	Value	Unit
Peak Pulse Power ( $T_P=8/20\mu s$ )	$P_{PP}$	240	W
ESD contact/air discharge (IEC-61000-4-2)	$V_{ESD}$	15/20	kV
Peak Pulse Current ( $T_P = 8/20\mu s$ )	$I_{PP}$	6	A
Junction Temperature	$T_J$	-55 to +125	°C
Storage temperature	$T_{STG}$	-55 to +150	°C

### Electrical Characteristics

( $T_A = 25$  °C unless otherwise specified)

Parameter	Symbol	Condition	Min	Typ	Max	Unit
Reverse stand-off Voltage	$V_{RWM}$				24.0	V
Reverse Breakdown Voltage	$V_{BR}$	$I_T=1mA$	26.7			V
Reverse Leakage Current	$I_R$	$V_R = 24.0V$			1	$\mu A$
Clamping Voltage (IEC 61000-4-5)	$V_C$	$I_{PP} = 6A$		44		V
Junction Capacitance	$C_J$	$V_R=0V, f=1MHz$		20		pF

**Typical Characteristics** ( $T_{amb} = 25\text{ }^{\circ}\text{C}$  unless otherwise specified)

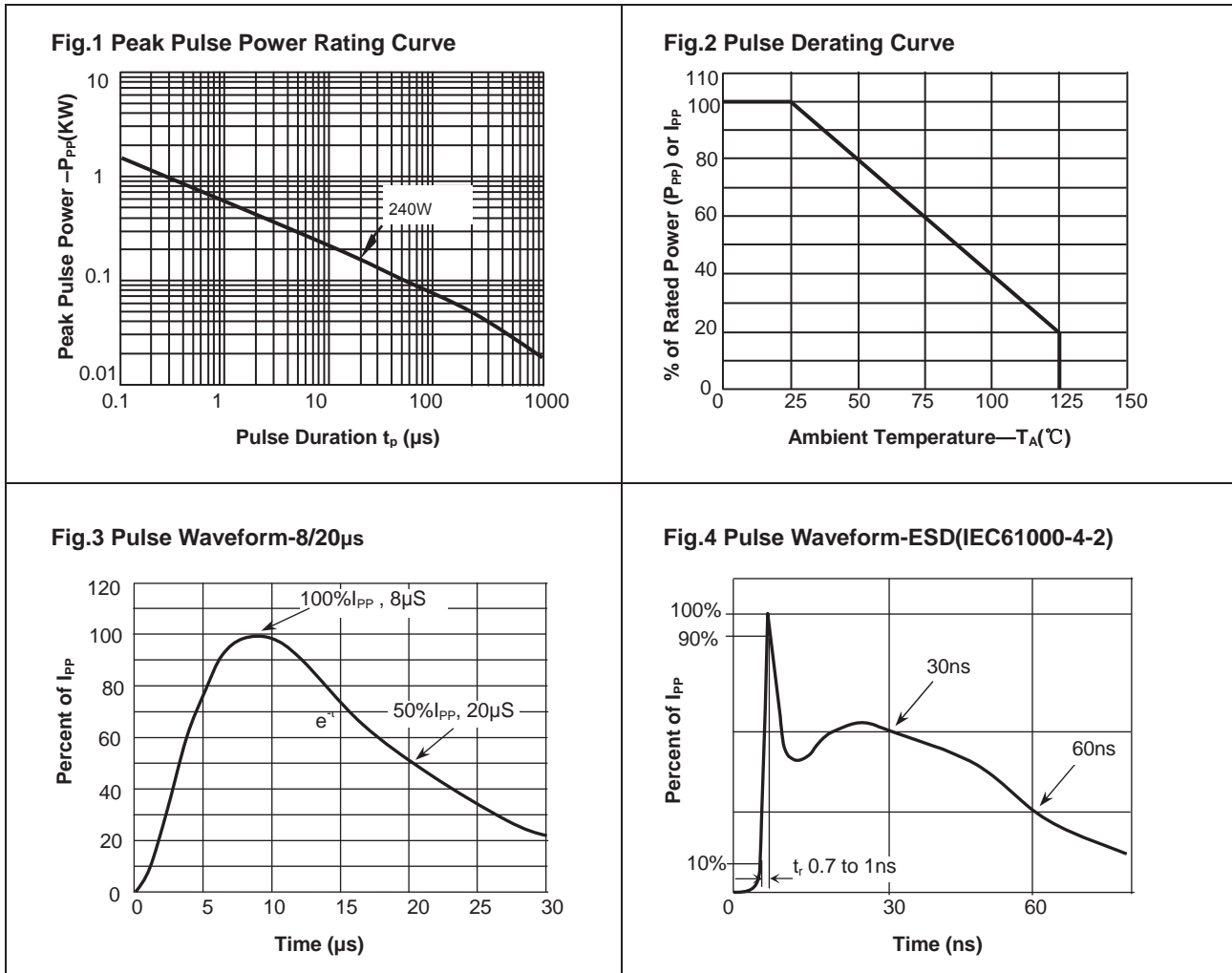

**Package Dimensions**

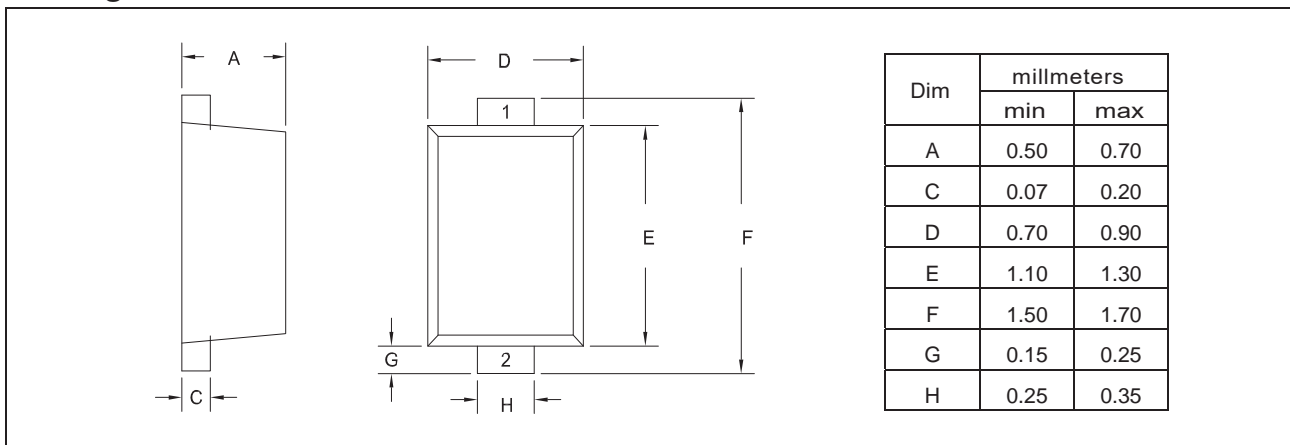

### Pad Dimensions

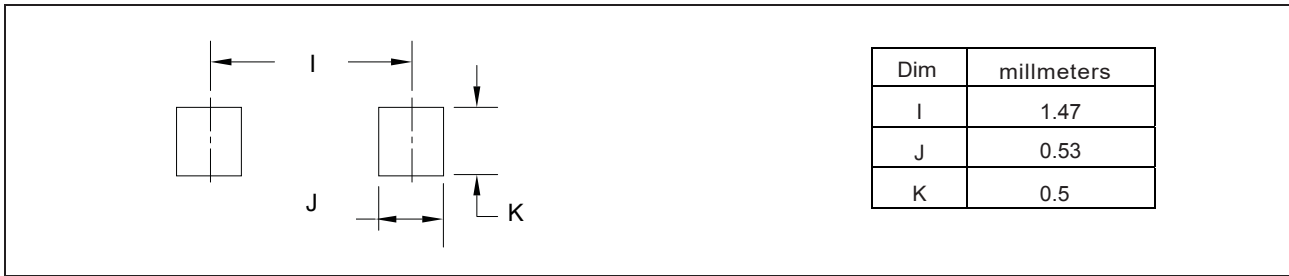

### Package Dimensions

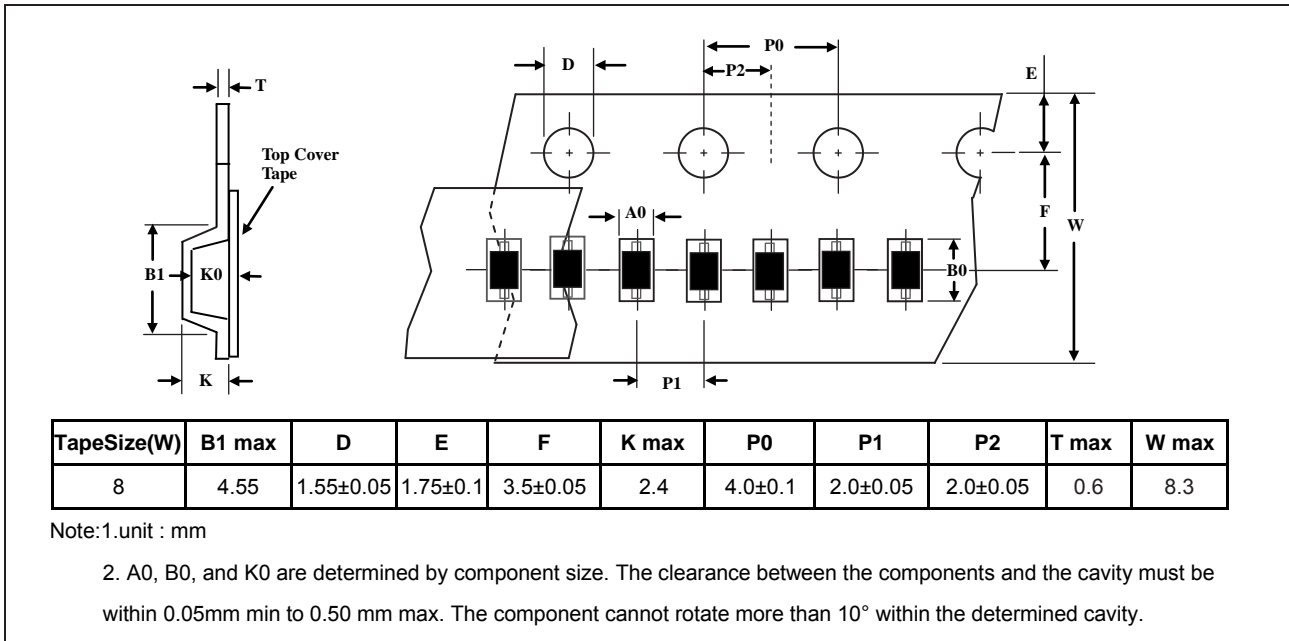

### Marking



### Ordering information

Order code	Package	Packaging option	Base quantity	Packaging specification
YEDSD522406AG	SOD-523FL	Tape and reel	5000pcs / reel	EIA STD RS-481